



Groove and glue
2mm wrapped
using medium C

Remove Material

FOAMe IIx 3D Park Flyer Design

ie in
carbon tube
CA.

Bottom wing cut from one pi



Cut
Dry

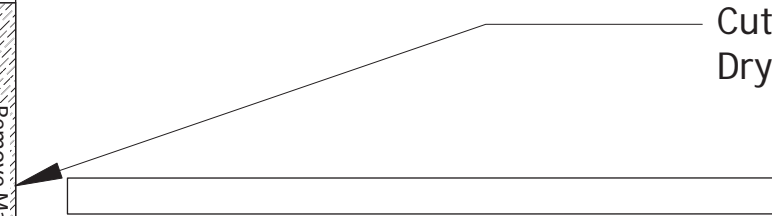

igned by Steven Gibson

iece of 6mm Depron foam

6mm slots for strut tabs.
fit and trim excise.

Strengthened with 4mm carbon fiber tube (bottom
channel (per plan) on the bottom of the bottom wi
use RC Z 56.

Remove Material

Aileron servos.

Use Dubro Mini
E/Z Conneters

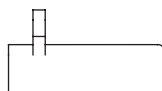

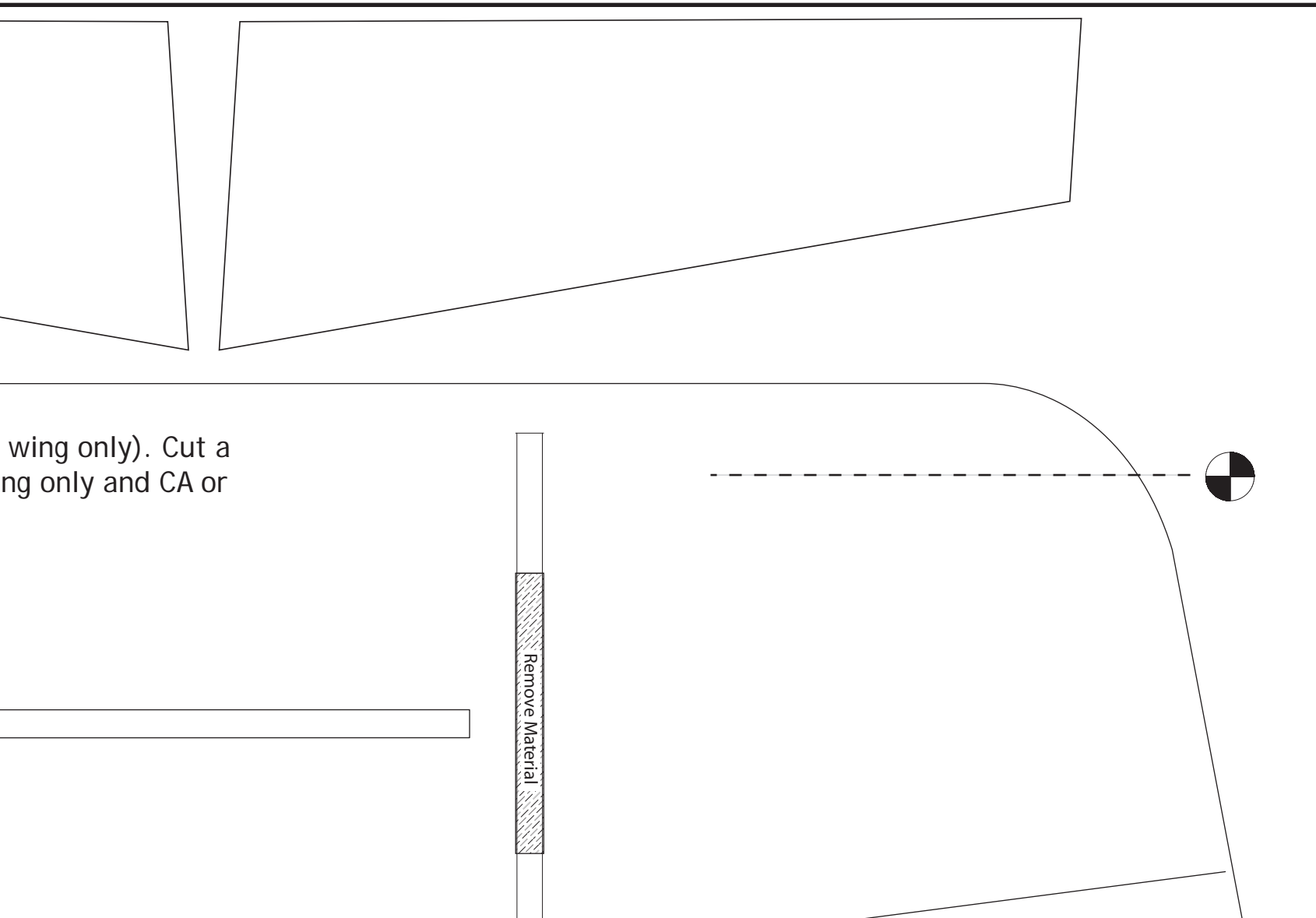

wing only). Cut a
ng only and CA or

Remove Material

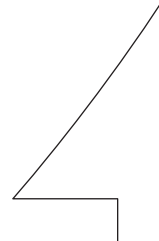



Rear

Front

Remove Material

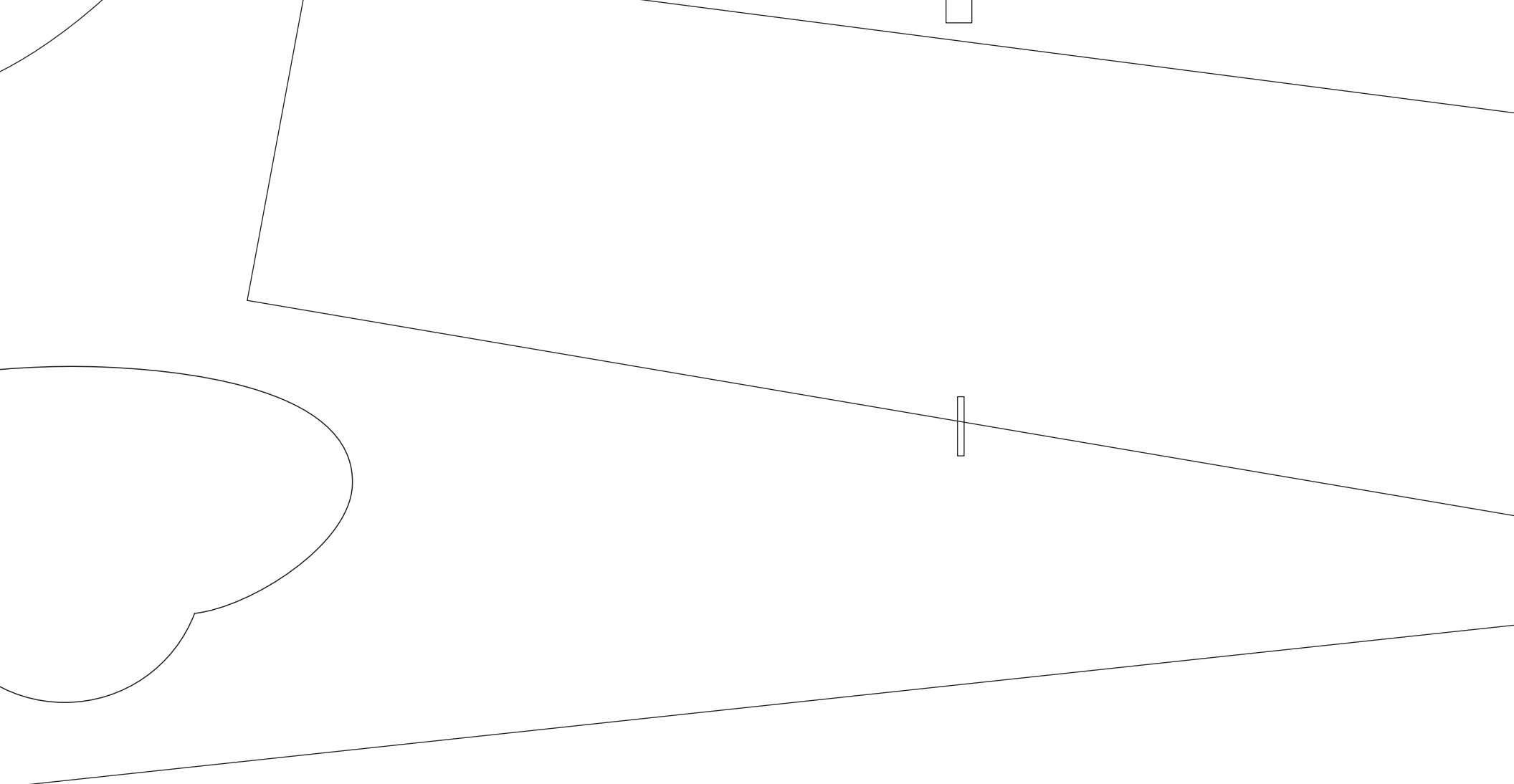

TOP wing cut from one piece of 6mm Depron foam

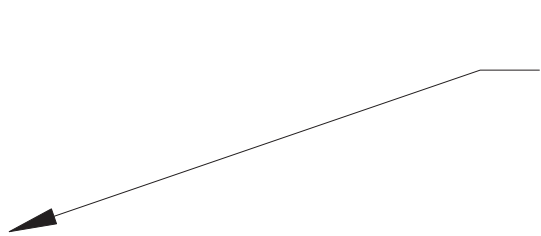

Cut 6mm slots for strut tabs.
Dry fit and trim excise.



for easy adjustments.
Mount using 3M
Double Coated
Industrial Foam Tape

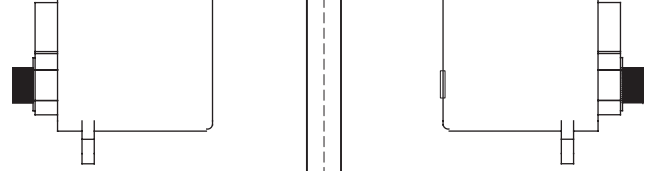

Bottom Wing



FOAMeII^x3D

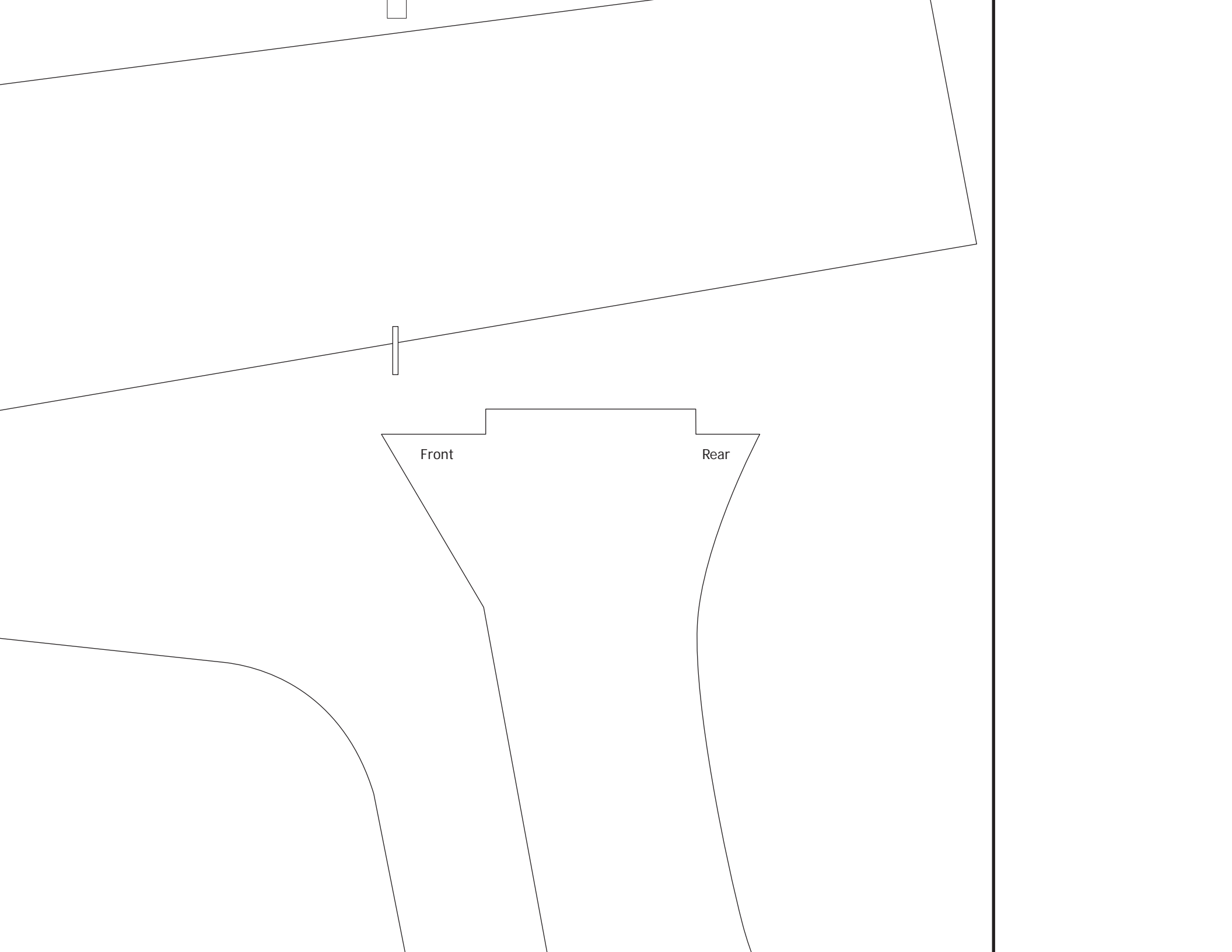

Front

Rear



Remove Material

3D
Batix.com



Aileron to aileron control horns. Cut a slot for horn dry fit, remove and CA back in place. See aileron detail diagram.



Top

Material

Tip: Fabricate Aileron to Aileron control horns out of Dubro Micro 90 Bellcranks. Use medium CA to secure.

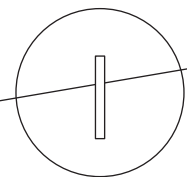
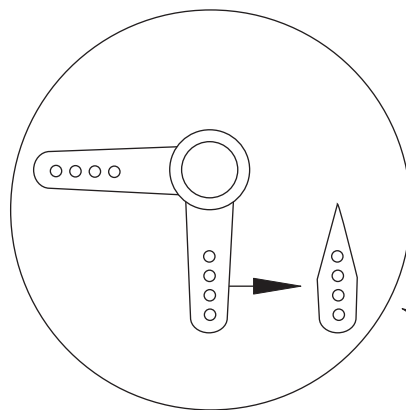

Top/bottom tabs are extended to a trimming during dry fitting of wing



Wing

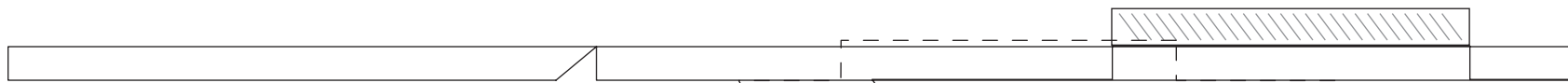

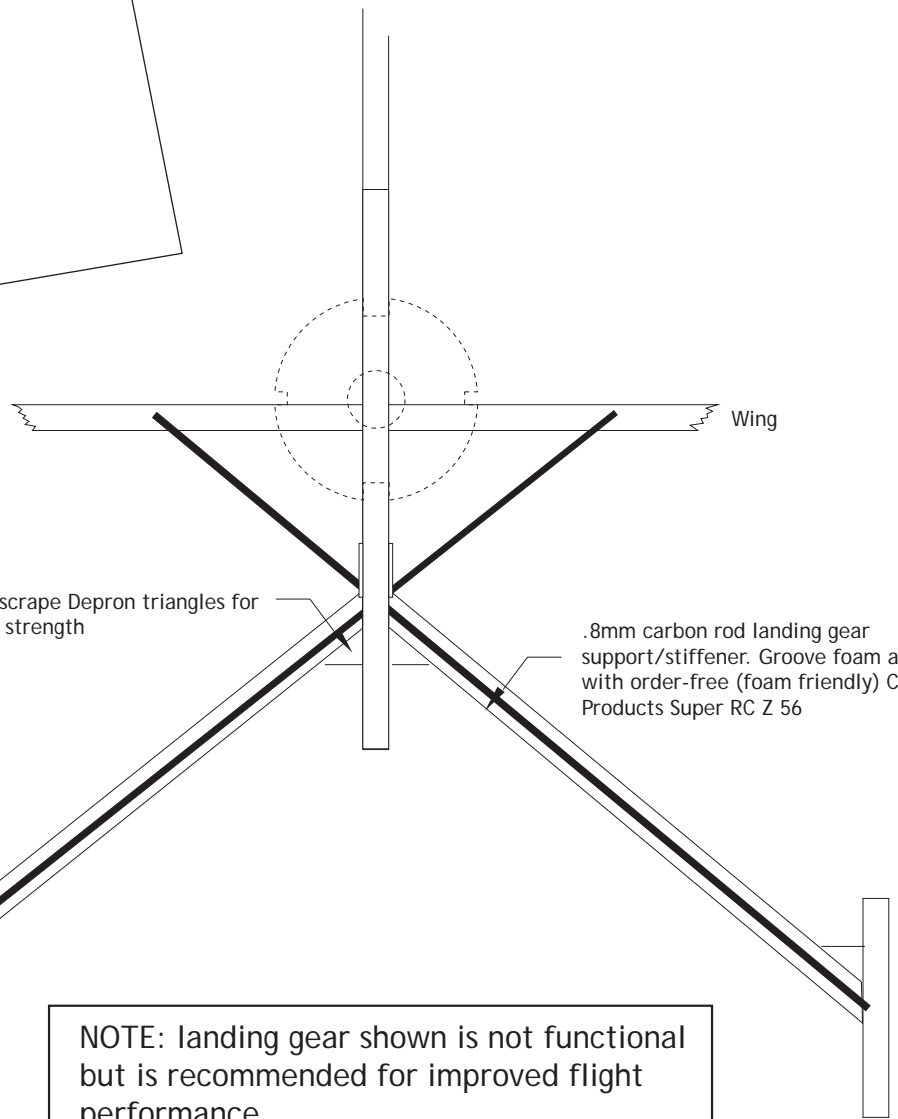
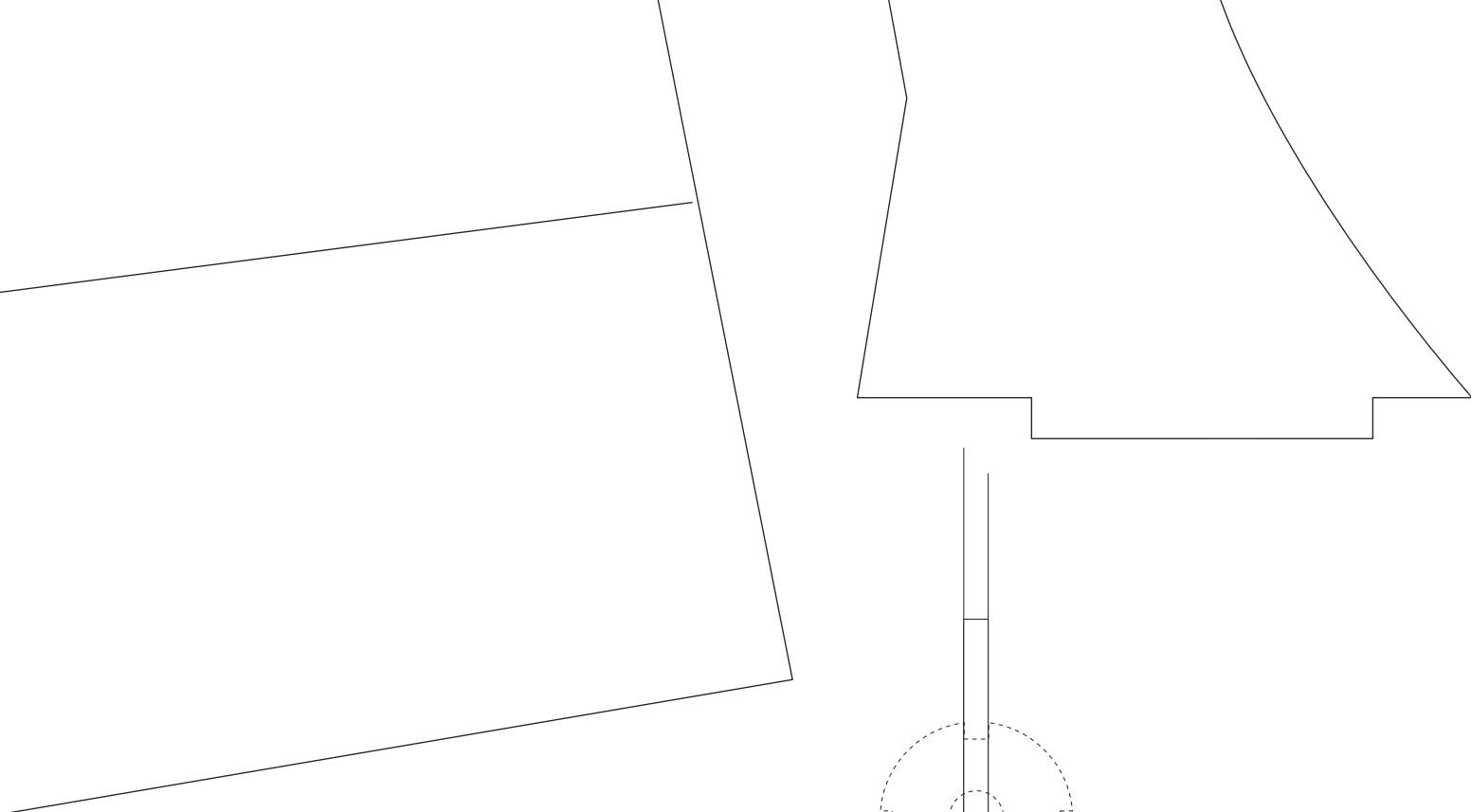

allow for flush

Glue scrape Depron triangles for extra strength

.8mm carbon rod landing gear support/stiffener. Groove foam and glue with order-free (foam friendly) CA or JZ Products Super RC Z 56

NOTE: landing gear shown is not functional but is recommended for improved flight performance



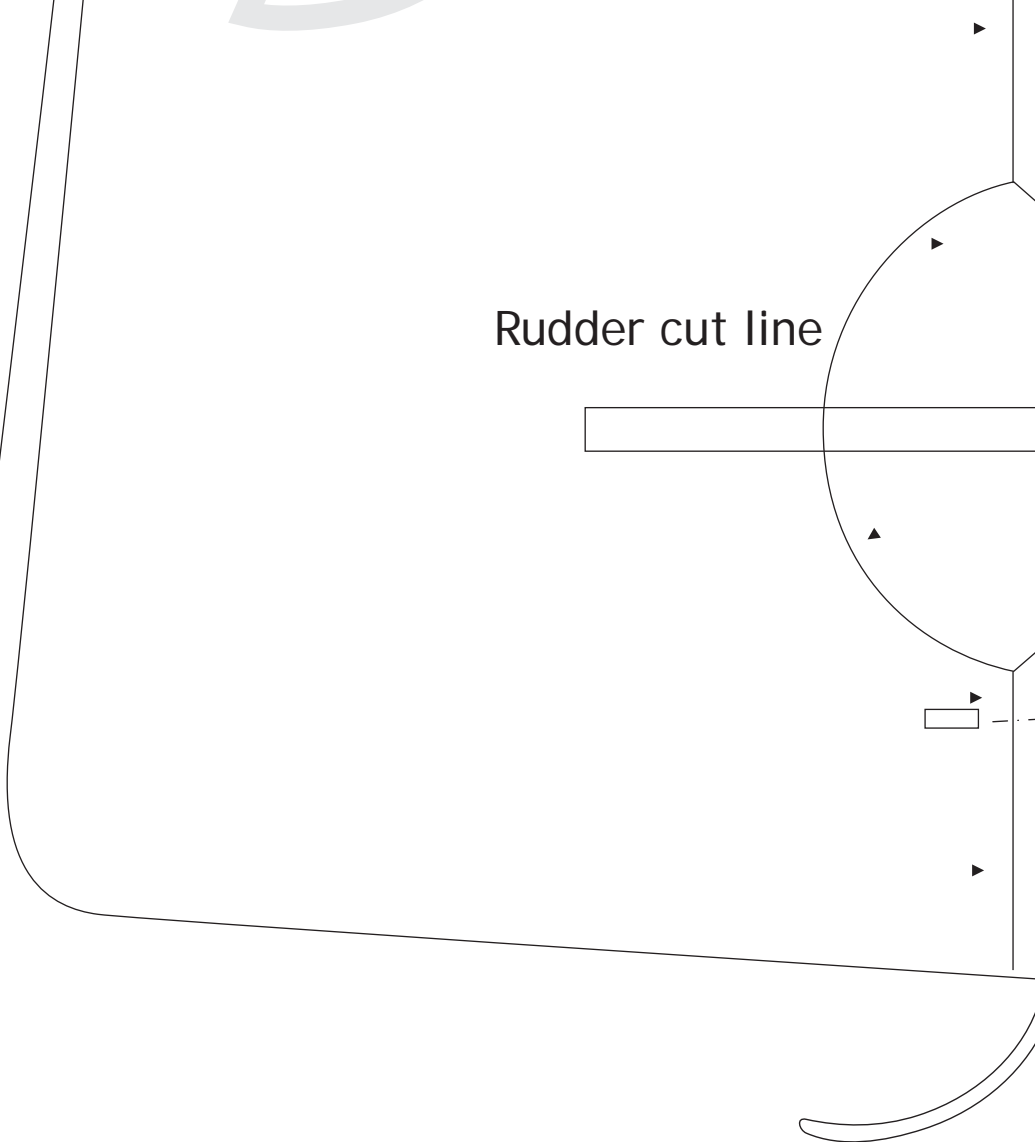
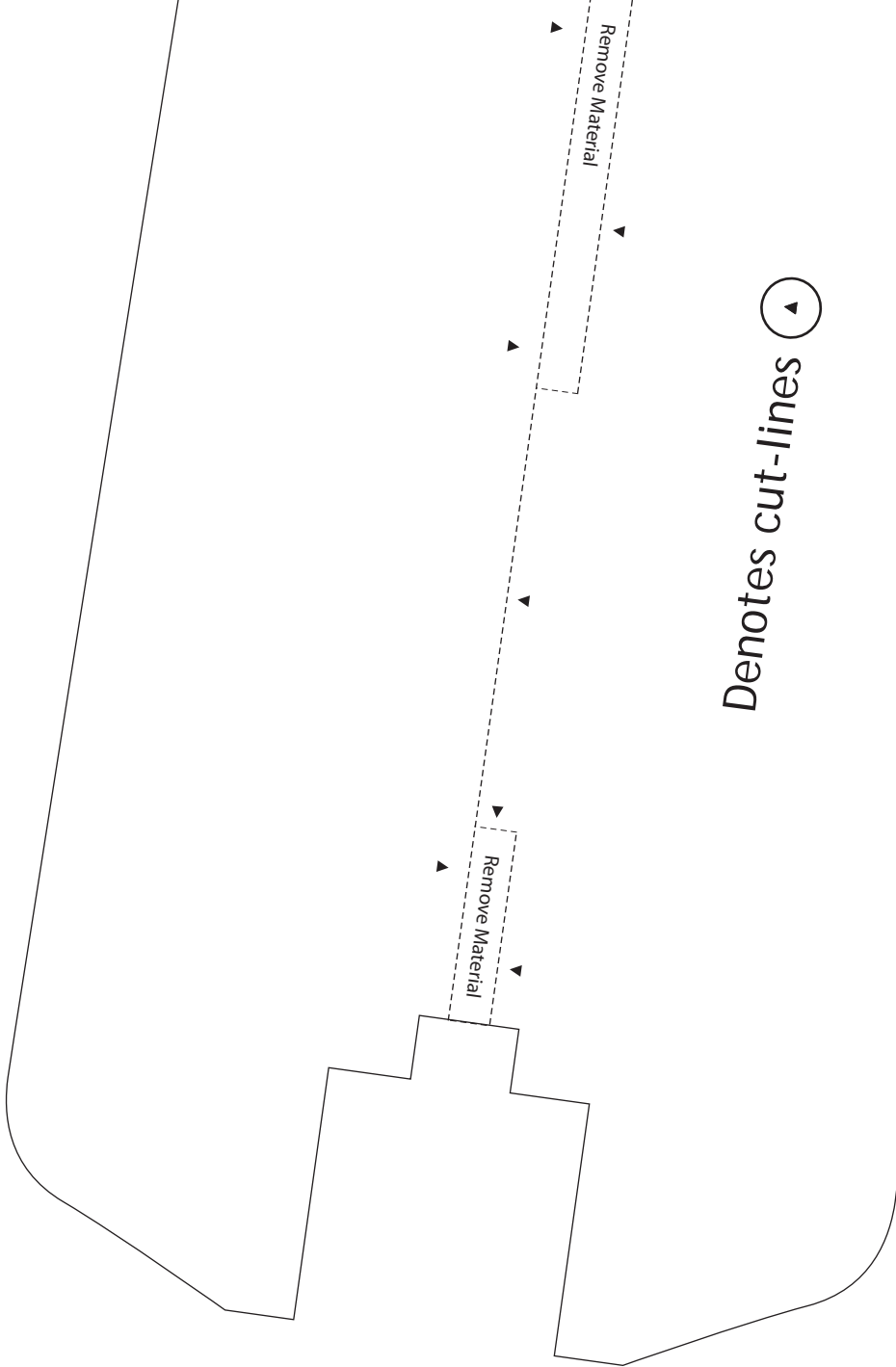

FOAMe IIx 3 D PARK FLYER SPECS	FLIGHT SYSTEM
Wing Span..... 30.5"	Rx and Servos
Length.....33"	* GWS R-6NII 5ch rc
Weight.....14-15oz	* 4 Waypoint W-084
Power..... AXI 2212/34	or Hitec HS 55
Prop..... GWS 12x6 Slow flyer	Brushless Motor
Ch..... 5 (4 servos + speed controller)	* AXI 2212/34 outru
Battery..... 3 Cell 700 to 1320mAh Li Poly	Speed Controller
	* Phoenix 25amp sp

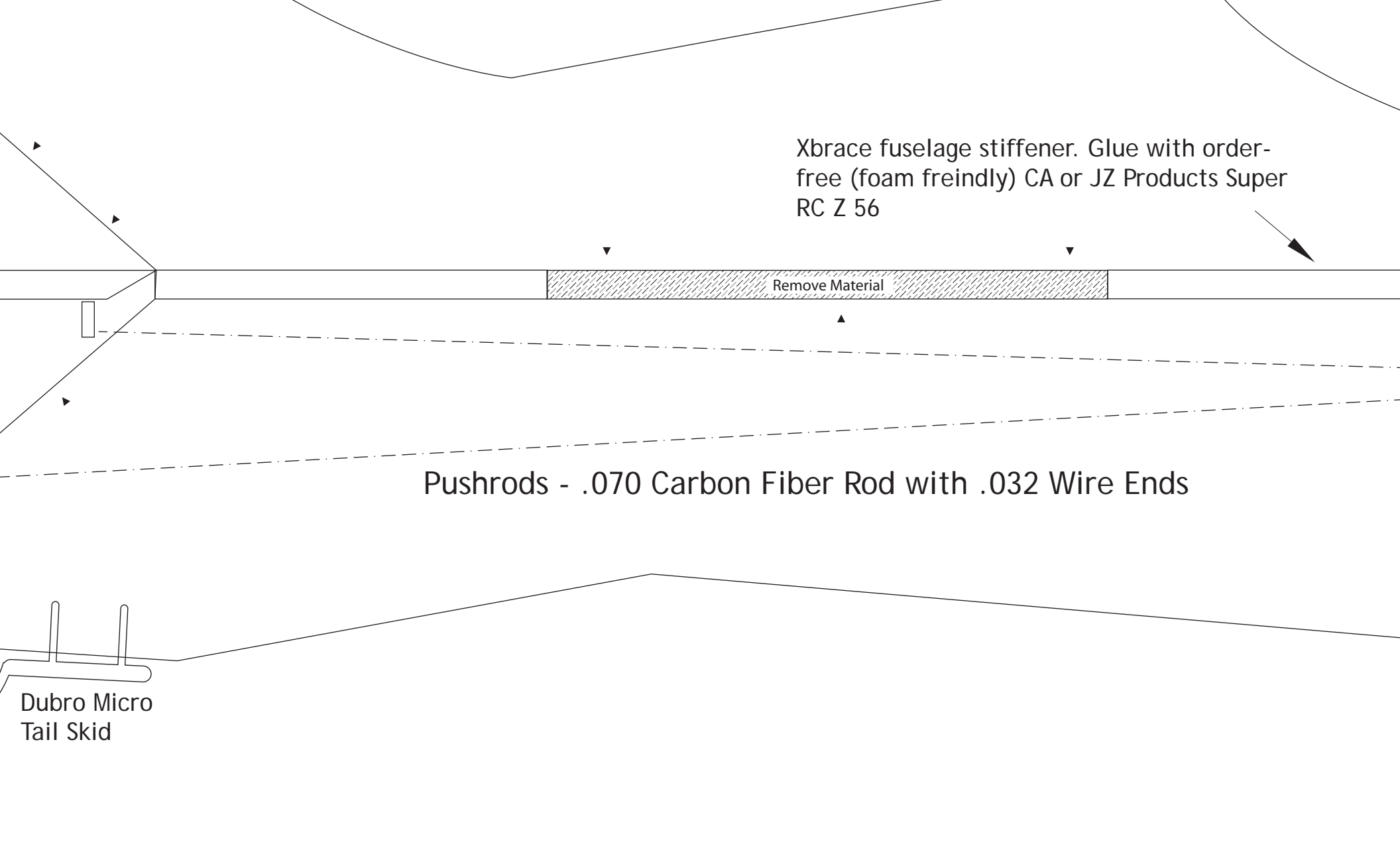

Xbrace fuselage stiffener. Glue with order-free (foam freindly) CA or JZ Products Super RC Z 56

Remove Material

Pushrods - .070 Carbon Fiber Rod with .032 Wire Ends

Dubro Micro Tail Skid

RECOMMENDATIONS

MATERIALS LIST

HINGE DETAIL

PUSHROD DETAIL

Receiver or equivalent
Micro Servos

runner (Max 3D performance)

Speed controller

- * Depron 6mm (www.depronusa.com)
- * 30" 4mm & 2mm wrapped carbon fiber tube
- * .070 Solid Carbon Rod (push rods + stab support)
- * .080 Solid Carbon Rod (landing gear support)
- * Medium or Thick foam friendly CA
- * Foam friendly CA accelerator
- * JZ Products Super RC "Z" 56 glue
- * 1" Self-sticking Hook & Loop

Best results are achieved by using 1" wide Du-Bro RC Electric Flyer Hinge Tape (3M Blenderm) for all hinges. Clean all parts with rubbing alcohol before applying.

— Tape

Use on control servo arms. CA 3" of wire to 2mm carbon fiber rod, secure with 1" of heat shrinking tubing. Carbon rod fits opposite side of control arms, wire connects and holds rod in place

.032 wire control rods



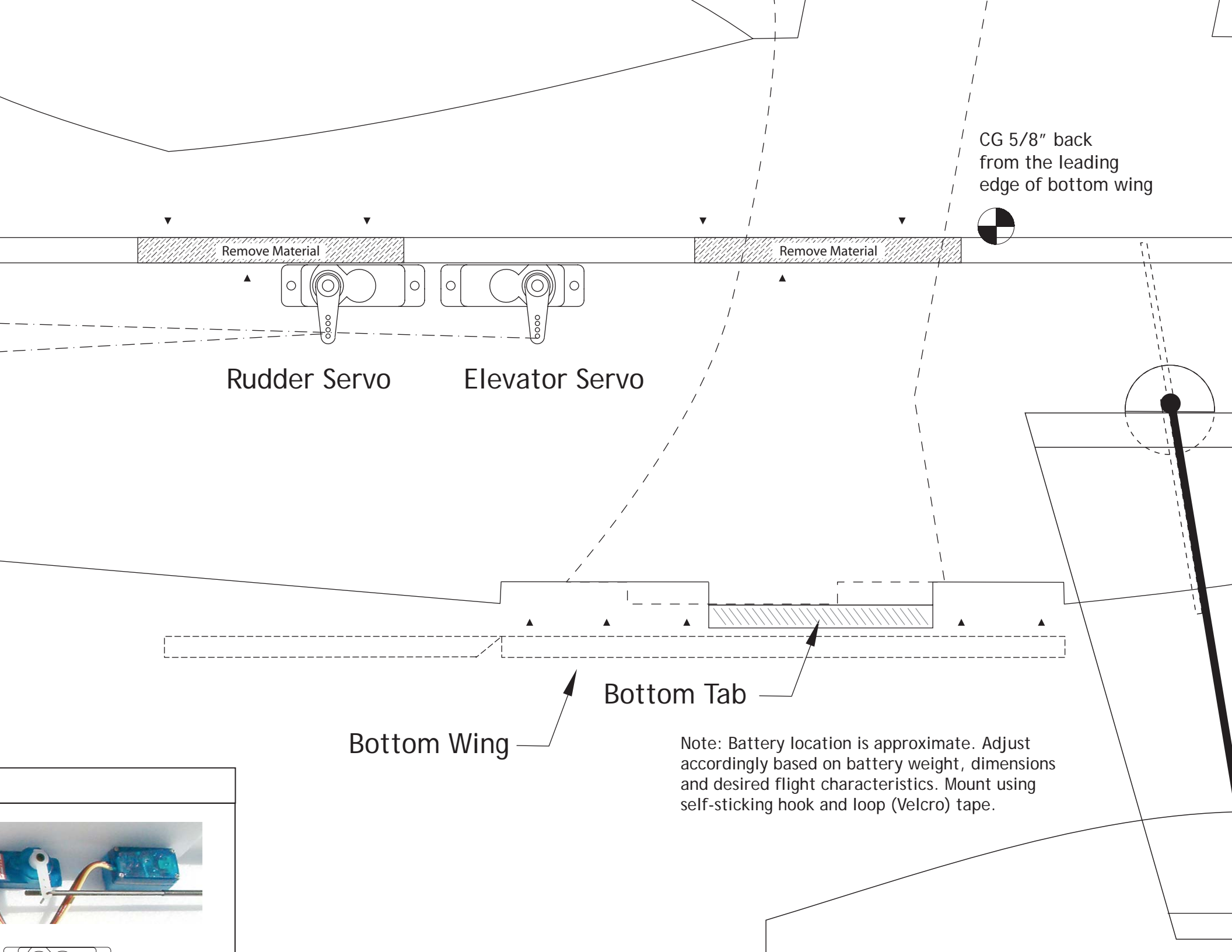

CG 5/8" back from the leading edge of bottom wing

Remove Material

Remove Material

Rudder Servo

Elevator Servo

Bottom Tab

Bottom Wing

Note: Battery location is approximate. Adjust accordingly based on battery weight, dimensions and desired flight characteristics. Mount using self-sticking hook and loop (Velcro) tape.

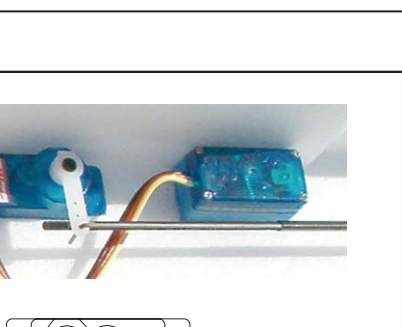

Denotes cut-lines (▲)

Remove Material

2-3 Cell
700-1300 mAh
Li-Poly Battery

AXI 2212/34
External Rotor
Brushless

1/8" light plywood radial mount,
reinforced with Depron triangle stock
on all 4 sides

Notch 1/8 lite plywood AXI
motor mount 6mm at
top/bottom.

Reinforce carbon rod
landing gear crossing
with 1/32 ply

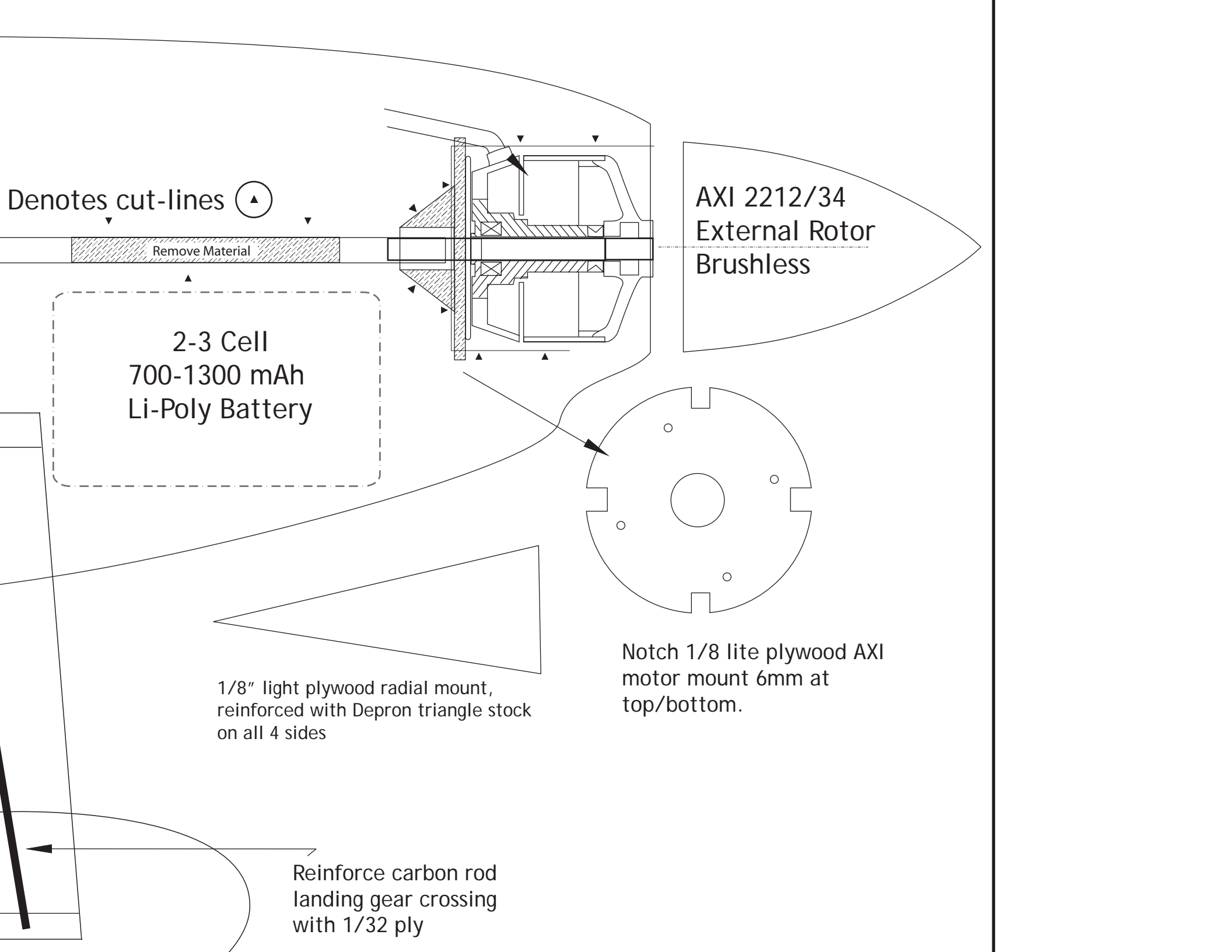

2
3
4

Battery..... 3 Cell 700 to 1350mAh-Li-Ion

Battery
* 3 Cell 700-1350m
Prop(s)
* GWS 12x6 Slow FI
* APC 12x3.8 electr

Inch Scale reference,
check after printing.

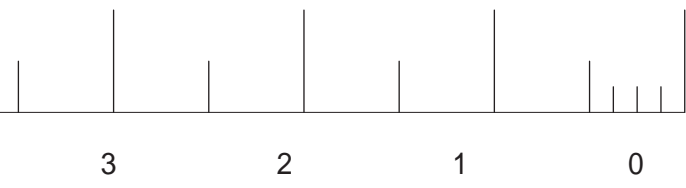

© Copyright 2005 3Dbatix.com. All rights reserved. rev-4.0305

Ah-11.1v Li-Poly

yer
ic slow flyer

- (Velcro-Industrial Strength) tape
- * Clear packing tape
- * 4-E-flite Micro Control Horns No. EFLA200
OR...4 Du-Bro Micro Control Horns No. 848
- * 4 Du-Bro Micro E/Z Links No. 849
- * .032 wire control arms
- * Du-Bro RC Electric Flyer Hinge Tape (3M Blenderm)
- * Zagi tape for trim scheme (optional)
- * Straight edge razor-blades
- * No. 11 Xacto knife
- * Metal yardstick
- * 3M Photomount Spray Adhesive
(for plan transfer to Depron)

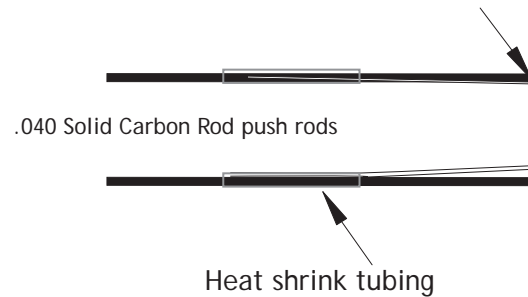
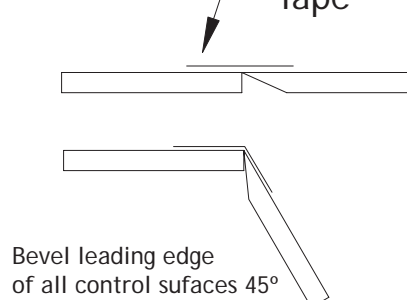

All airframe parts and control surfaces are cut f

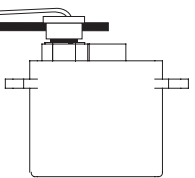
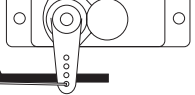

Lightly coat back of plan parts with Spray Adhesive, apply each part to Depron. Carefully cut each out using a strightedge and #11 Xacto.



Carefully cut each out using a strightedge and #11 Xacto.



Dry fit assembly--check alignment.



A Rotary Tool Cutting Adapter is perfect for clean, easy to make, grooves for Fiber Carbon rod wing spar. Glue spar in with RC Z 56 or medium/thick CA.

Look for more

from 6mm Deporn Foam

Build tips online at: 3Dbatix.com



Apply trim scheme before final assembly. Zagi tapw works great! It's best to trim each part before assembly.



Assemble using RC Z 56 or medium or thick CA. great for trim.